

# An Overview of CoCoME

*Hakim Hannousse*



ECOLE DES MINES DE NANTES

DEPARTMENT OF COMPUTER SCIENCE

- Context = Trading System
- Supports functional aspects : Manage sales, order products, .. etc.
- Supports non function aspects : Manage Express Checkout, Synchronization, RealTime Constraints ... etc.
- Extra-functional properties based on statistics for typical German super-markets

# CoCoME: A Single Cash Desk

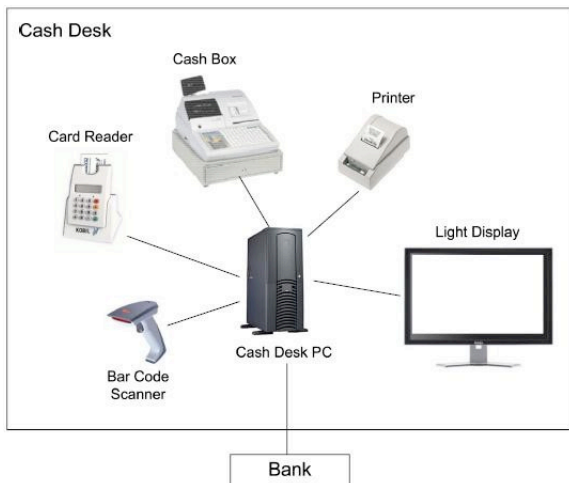

# CoCoME: A single Store

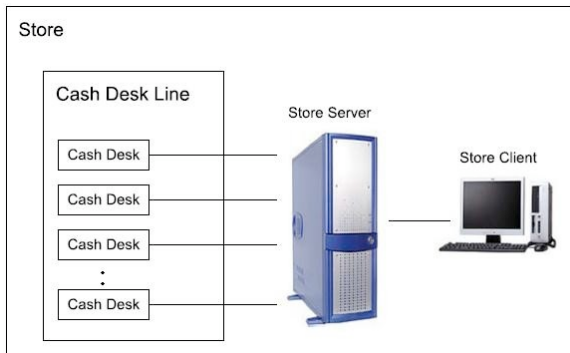

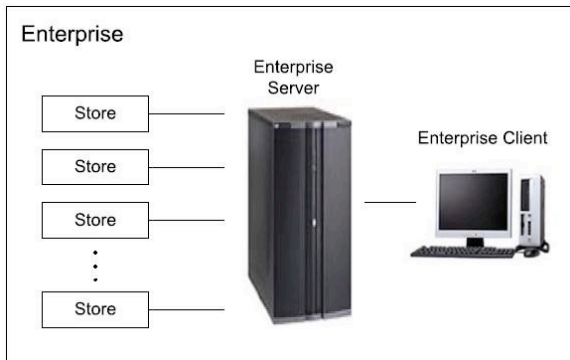

# CoCoME: Provided Use Cases

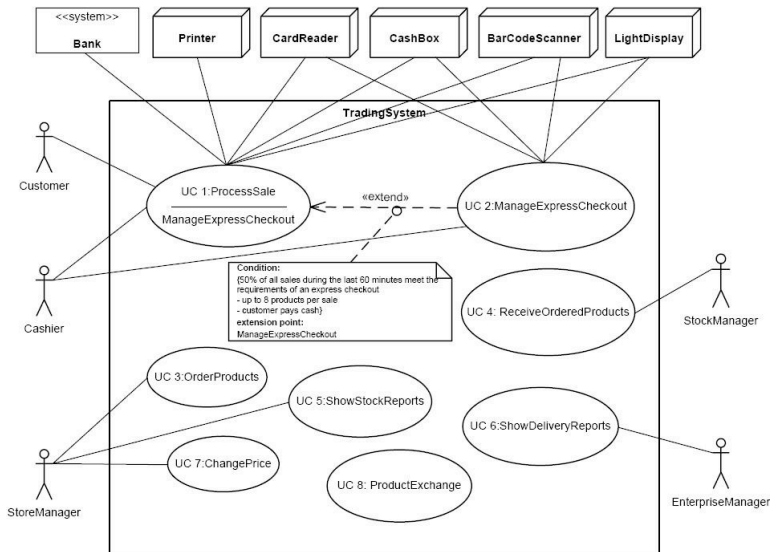

# CoCoME: Component Modularization - TradingSystem

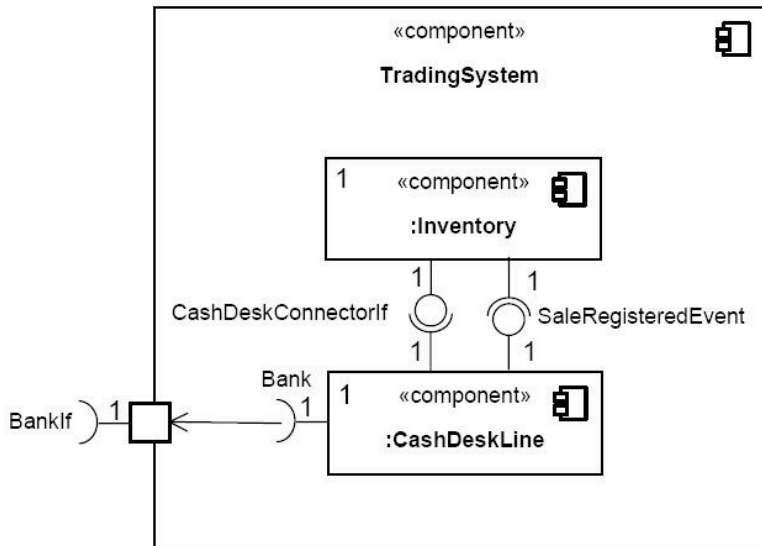

# CoCoME: Component Modularization - Inventory

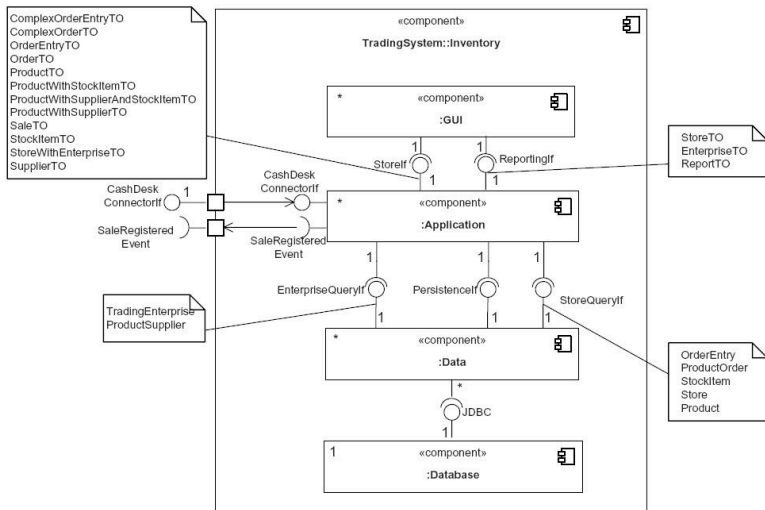



# CoCoME: Component Modularization - CashDeskLine

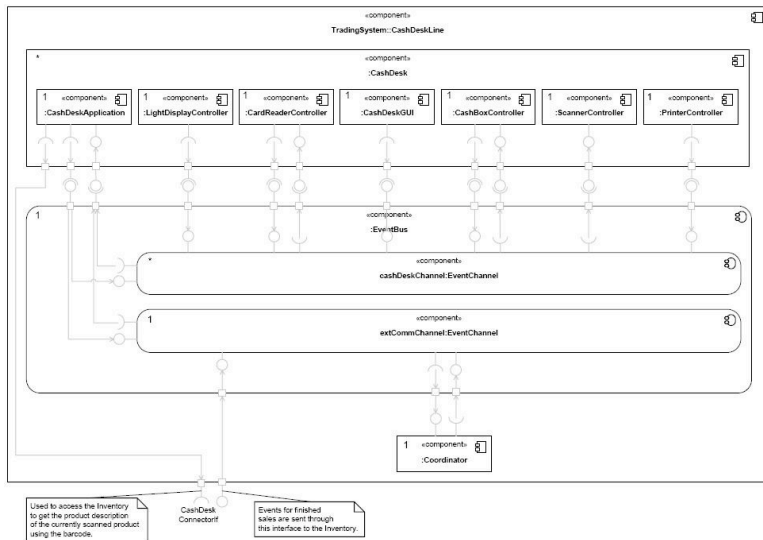

# CoCoME: Component Modularization - Deployment System

